

VMX-PFE™ Soft Starter Installation Instructions. To download installation instructions, scan the QR Code to the right or visit motortronics.com (Mobile device friendly).

Montageanweisung, Notice d'installation, Istruzioni per il montaggio, Instrucciones de montaje

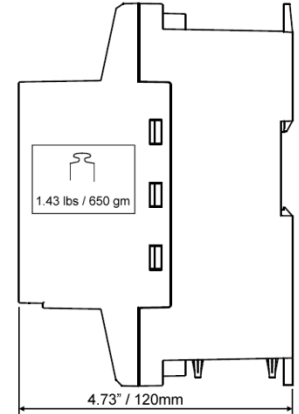
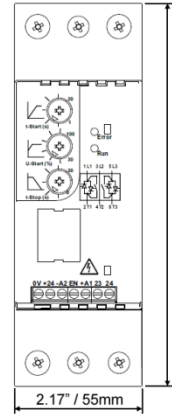
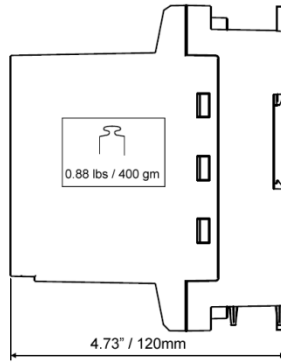
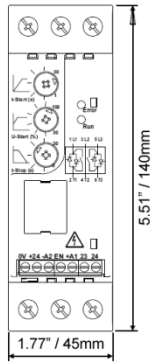
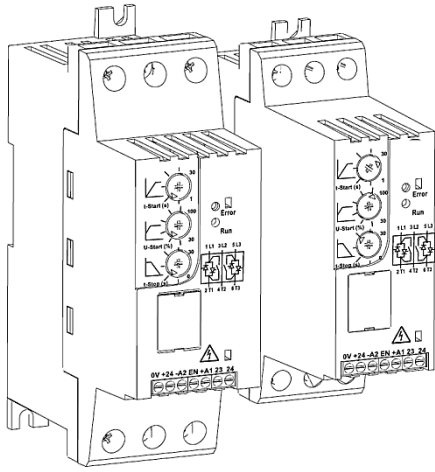

Mounting Centers 1.18" (30mm) x 5.2" (130mm)

Mounting Centers 1.57" (40mm) x 6.10" (155mm)

This device is suitable for use in industrial environments. EN 55011/22 Class A
 Das Gerät ist für den industriellen Einsatz geeignet EN 55011/22 Klasse A.
 L'appareil a été conçu pour l'emploi en milieu industriel EN 55011/22 classe A.
 L'apparecchio è adatto per uso in ambienti industriali EN 55011/22 Classe A.
 El aparato es adecuado para uso en ambiente industrial EN 55011/22 clase A

Size 1: 5 Amp to 16 Amp
VMX-PFE-02 2.2kW @ 400V 5Amp
VMX-PFE-04 3kW @ 400V 7Amp
VMX-PFE-06 4kW @ 400V 9Amp
VMX-PFE-08 5.5kW @ 400V 12Amp
VMX-PFE-10 7.5kW @ 400V 16Amp

Size 2: 22 Amp to 41 Amp
VMX-PFE-12 11kW @ 400V 22Amp
VMX-PFE-14 15kW @ 400V 30Amp
VMX-PFE-16 18.5kW @ 400V 36Amp
VMX-PFE-18 22kW @ 400V 41 Amp (Non UL)
VMX-PFE-18 30HP @ 460V FLA 40A (UL)

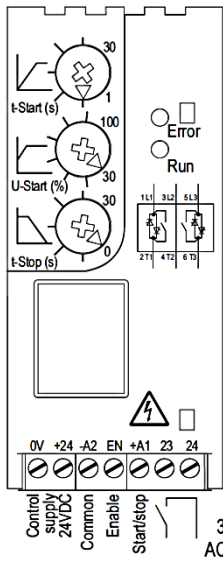

- Not Enabled** LED green+red - LED grün+rot - DEL vert+rouge - LED verde+rosso - LED verde+rojo
- Slow Flash** Initialisation - Initialisierung - Initialisation - Inizializzazione - Inicialización
- Run** LED green - LED grün - DEL vert - LED verde - LED verde
- Slow Flash** Ready for operation - Betriebsbereit - Prêt à fonctionner - Pronto al funzionamento - En condiciones para funcionamiento
- Quick Flash** Starting - in Rampe - en rampe - in rampa - en rampa
- Full On** Full volts - vollen Spannung - pleine tension - piena tensione - plena tensión
- Quick Flash** Soft-Stop - Soft stop - Arrêt progressif - Soft-Stop - Paro suave

Very quick green flash- Starting to trip on over current

- Error** Fault LED red - Fehler LED rot - DEL erreur rouge - LED errore rosso - LED error rojo
- | | | | |
|---|--------------------------|---|----------------------|
| 1 | SCR or supply | 2 | Too hot |
| 3 | Control supply low volts | 4 | Bypass relay failure |
| 5 | Shearpin (4.4 x 1e) | 6 | Overcurrent |

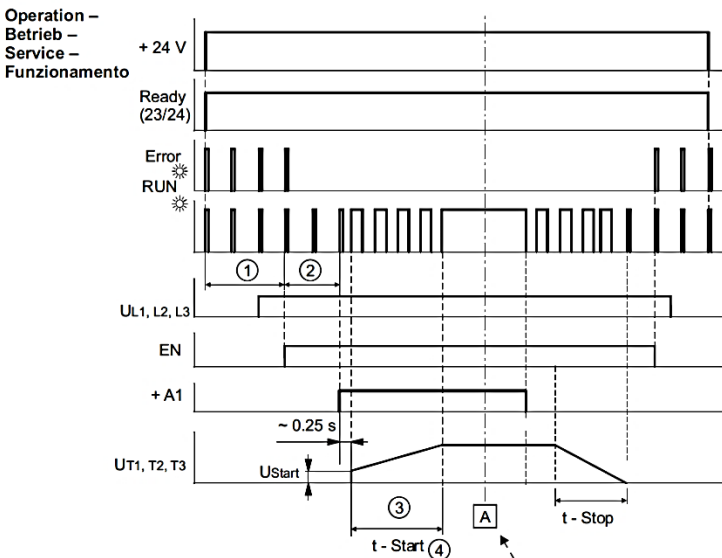
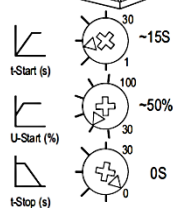
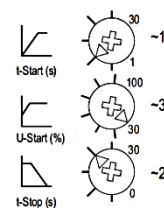
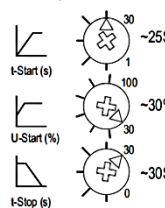
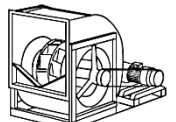
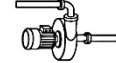
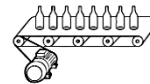
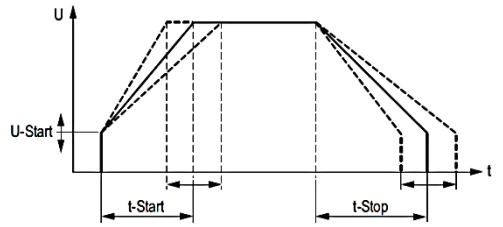
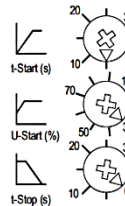

Fault - Störung - Défaut - Guasto - Avería

- RUN-LED green - RUN LED grün - DEL RUN verde - RUN-LED -
 Error-LED red - Error LED rot - DEL erreur rouge - LED errore rosso - LED error rojo
- 1 Initialisation - Initialisierung - Initialisation - Inizializzazione - Inicialización
 - 2 Ready for operation - Betriebsbereit - Prêt à fonctionner - Pronto al funcionamiento - En condiciones para funcionamiento
 - 3 in ramp - in Rampe - en rampe - in rampa - en rampa
 - 4 Top of ramp - Rampenende erreicht - Fin de rampe atteinte - Fine rampa - Fin de rampa

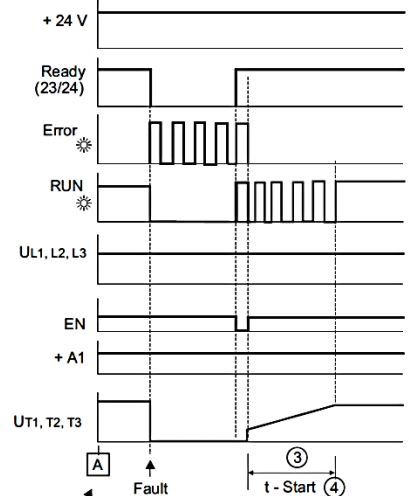

0V, +24
+ A1, E, -A2
23, 24

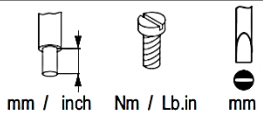

mm ² / AWG		mm / inch	Nm / Lb.in	mm
1 x	0.5 - 2.5 / 20 - 14	6 / 1/4"	0.4 / 3.5	0.6 x 3.5
2 x	0.5 - 1.5 / 20 - 16			

Meldereleais – Signalling relay – Relais à voyant – Relè di segnalazione – Relé de señalización

U	(L)	(R) AC11	I _{min}	U _{min}
250V AC	0.2A	2.5A	10mA	100V AC
30V DC	0.7A	3A	100mA	5V DC



DANGER! Hazardous Voltage. Will cause death or serious injury. Hazardous voltage is also present in the OFF/STOP status of the soft starter when the supply voltage is switched on (Ue).
GEFAHR! Gefährliche Spannung. Lebensgefahr oder schwere Verletzungsgefahr. Bei eingeschalteter Versorgungsspannung (Ue) steht auch im AUS-/STOP-Zustand des Softstarters am Ausgang gefährliche Spannung an.
DANGER! Tension dangereuse. Danger de mort ou risque de blessures graves. En cas de tension d'alimentation (Ue) endenchée, la tension dangereuse existe aussi en position d'Arrêt à la sortie du démarreur progressif.
PERICOLO! Tensione pericolosa. Può provocare morte o lesioni gravi. Con la tensione di alimentazione (Ue) inserita, anche nello stato OFF/STOP del softstarter è presente tensione pericolosa in uscita.
¡PELIGRO! Tensión peligrosa. Puede causar la muerte o lesiones graves. Si la tensión de alimentación está conectada (Ue), existe también en la salida tensión peligrosa con el arrancador suave en estado OFF/ON.

PFE-02 to PFE-10
1 L1, 3 L2, 5 L3
2 T1, 4 T2, 6 T3

75°C wire
CU only

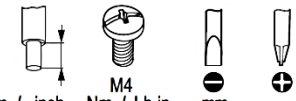

mm ² / AWG		mm / inch	Nm / Lb.in	mm	
1 or 2 x	1 - 4 / 18 - 12	9 / 3/8"	1.3 / 12	1 x 6	PZ2

PFE-12 to PFE-18
1 L1, 3 L2, 5 L3
2 T1, 4 T2, 6 T3

75°C wire
CU only



mm ² / AWG		mm / inch	Nm / Lb.in	mm	
1 or 2 x	2.5 - 10 / 12 - 8	12 / 1/2"	2.5 / 22	1 x 6	PZ2

Where several conductors are to be connected, the difference between the wires/cables used must not exceed one DIN Standard size level.
 Bei Mehrleiteranschluss darf maximal ein DIN-Normgrößen-Sprung zwischen den verwendeten Leitern liegen.
 En cas de raccordement de plusieurs conducteurs, il faut 1 écartement normalisé max. entre les conducteurs.
 In caso di collegamento a più conduttori, è ammesso al massimo un salto di grandezze DIN standard fra i conduttori utilizzati.
 En caso de conexión de múltiples conductores puede haber como máximo un salto de magnitud normalizada DIN entre los conductores utilizados.

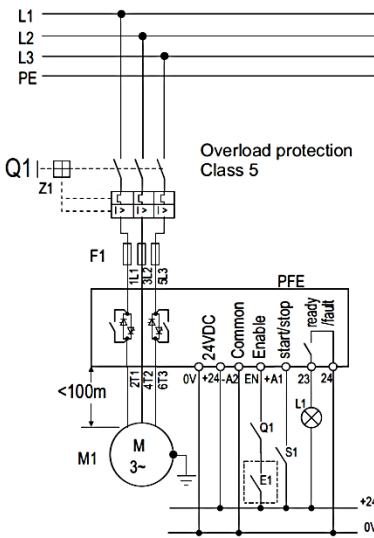

F1 = Coordination Type1
 Recommended Semiconductor Fuses
 PFE-02 to PFE-08 SIBA 2018920-35
 PFE-10 SIBA 2018920-40
 PFE-12 to PFE-18 SIBA 2018920-125

UL Requirement - Short Circuit rating 5000A, 480Vac when protected by fuses or circuit breakers, rated as indicated in table below

MODEL #	Class J or T Fuse Rated 600VAC	Circuit Breaker Rated 600VAC
PFE-02	15A	-
PFE-04	15A	-
PFE-06	30A	-
PFE-08	40A	-
PFE-10	50A	-
PFE-12	80A	80A
PFE-14	100A	100A
PFE-16	125A	125A
PFE-18	150A	150A

Control Circuit Elements
 E1 = Optional switch to allow trip reset without opening main breaker Q1
 Q1 = Auxiliary contact of main breaker Q1
 S1 = Start/Stop control switch
 L1 = Indicator:
 On: Ready
 Off: Fault

Rated Impulse withstand Voltage (Uimp) 2.5kV
 Rated Insulation Voltage (Ui) 500V
 Pollution Degree 2
 Rated Short Circuit Current (Iq)* 5kA
 Short Circuit Co-ordination* Type 1
 Surrounding Air Temperature 0°C to 40°C.
 Above 40°C de-rate linearly by 2% of unit FLC per °C to a derate of 40% at 60°C (not UL)
 Transport and Storage -25°C to +60°C
 Altitude 1000m. 1000-2000m de-rate 1% of unit FLC per 100m to 2000m.
 Humidity max. 85% non-condensing, not exceeding 50% at 40°C
 IP Rating IP20
 Design Standards IEC 60947-4-2; EN60947-4-2
 AC Semiconductor Motor Controllers and Starters
 United States Standard UL508
 * When protected by recommended semiconductor fuse.

- Q1 = Cable protection - Leitungsschutz - Protezione di linea - Protección de cable - Protection de câbles
- Z1 = Overload relay - Überlastrelais - Relè termico - Relé de sobrecarga - Relais thermique
- F1 = Semiconductor fuse for type 1 coordination, in addition to Q1
 Halbleitersicherung für Zuordnungsart 1, zusätzlich zu Q1
 Per avere la protezione del semiconduttore in coordinamento di tipo 1, è necessario un fusibile in aggiunta a Q1
 Fusible semiconductor para tipo de coordinación 1, adicionalmente a Q1
 Fusible pour semi-conducteurs pour coordination de type 1, additionnel à Q1
- PFE = Soft Starter - Halbleiterschütz - Contactor semiconductor - Contattore a semiconduttori - Contacteur à semi-conducteurs
- A1-A2 = Start/Stop - Start/Stop - Start/Stop - Arranque/Parada - Démarrage/Arrêt



Electric shock risk. Danger
 Only skilled or instructed persons may carry out the following operations.
 Lebensgefahr durch elektrischen Strom!
 Nur Elektrofachkräfte und elektrotechnisch unterwiesene Personen dürfen die im Folgenden beschriebenen Arbeiten ausführen.
 Tension électrique dangereuse !
 Seules les personnes qualifiées et averties doivent exécuter les travaux ci-après.
 Tensione elettrica: Pericolo di morte!
 Solo persone abilitate e qualificate possono eseguire le operazioni di seguito riportate.
 ¡Corriente eléctrica! ¡Peligro de muerte!
 El trabajo a continuación descrito debe ser realizado por personas cualificadas y advertidas.

Operational Voltage (Ue) 230-460 VAC rms 3-Phase (-15% +10%)
 Rated Frequency 50 - 60Hz +/- 2Hz Form Designation Form 1
 Index Rating Standard (Class5) AC53b: 3-5: 355
 Overcurrent = > 3 x Ie for 5 Seconds
 Control Supply Us 24V DC approx 4VA supplied to terminals 0V - +24V
 Enable Control 24V DC galvanically isolated terminals -A2 - EN
 Start/Stop Control 24V DC galvanically isolated terminals -A2 - +A1
 Auxiliary Circuits relay Ready/Fault - 23/24. 250VAC 2.5A, AC11.
 Indication Red = Error - Green = Run LEDs
 t-Start 1 to 30 seconds.
 U-Start 30% - 100%
 t-Stop 0 to 30 seconds
 Start Duty 3 x FLC for 5 seconds at standard rating
 Starts / Hour standard 10 starts per hour or 5 starts + 5 soft stops per hour
 with optional fan 60 starts per hour or 30 starts + 30 soft stops per hour
 Internally bypassed
 Power Terminals IP20 Rated wire clamping terminals

Listed Soft starter can be used when fitted with fan part numbers as detailed in document M-7G71-F

EMC EMISSION AND IMMUNITY LEVELS		
ESD immunity	IEC 61000-4-2	4kV contact, 8kV air discharge
R F immunity	IEC 61000-4-6	140dBuV over 0.15-80MHz
R F immunity	IEC 61000-4-3	10V/m over 80 - 1000MHz
Fast Transient immunity	IEC 61000-4-4	2kV/5kHz
Surge immunity	IEC 61000-4-5	2kV line to ground, 1kV line to line
Conducted RF emissions	EN 55011	Class A
Radiated RF emissions	EN 55011	Class A

Phasetronics Inc. dba Motortronics

1600 Sunshine Drive
 Clearwater, Florida 33765
 Tel: 727-573-1819
 Fax: 727-573-1803

Info/Sales: sales@motortronics.com

PFE-QSL-103020

California Customers: California Proposition 65 Warning

WARNING: This product and associated accessories may contain chemicals known to the State of California to cause cancer, birth defects, or other reproductive harm. For more information visit <https://p65warnings.ca.gov>