

Wound Primary Indoor Current Transformer

Model CTW5-L-110
CTWH5-L-110 rev 051223

CERTIFICATIONS:



APPLICATION:

Relaying and metering

FREQUENCY:

50-400 Hz.

CONTINUOUS THERMAL RATING

FACTOR:

1.00 at 30°C., 0.85 at 55°C

APPROXIMATE WEIGHT:

34 lbs.

CONNECTIONS:

Primary terminals are ½ - 13 bolts with one Belleville washer.

Secondary terminals are brass screws No. 10-32 with one flatwasher, lockwasher.

Vacuum cast in polyurethane resin.

Other ratios, secondary currents and dual ratios are available. Refer to factory.

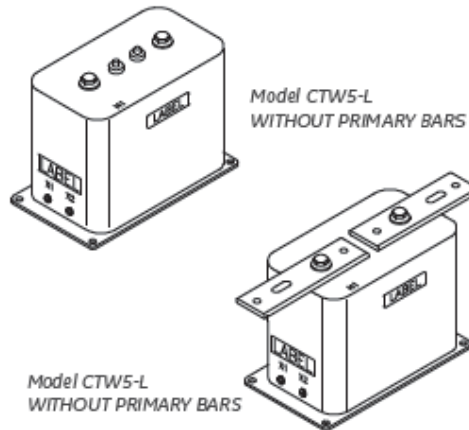

MODEL 1CTW5-L-110 & CTWH5-6-110

Window Diameter 6.00"

Approximate weight: 34 lbs.

Catalog Number	Current Ratio	Relay Class	ANSI Metering Class at 60 Hz					**Thermal current Rating 1 Second RMS Amps
			BO.1	BO.2	BO.5	BO.9	B1.8	
CTW5-L-110-T20-050	5:5	T20	0.3	0.3	0.6	1.2	2.4	375
CTW5-L-110-T20-100	10:5	T20	0.3	0.3	0.6	1.2	2.4	590
CTW5-L-110-T20-150	15:5	T20	0.3	0.3	0.6	1.2	2.4	1,200
CTW5-L-110-T20-250	25:5	T20	0.3	0.3	0.6	1.2	2.4	1,700
CTW5-L-110-T20-300	30:5	T20	0.3	0.3	0.6	1.2	2.4	1,700
CTW5-L-110-T20-400	40:5	T20	0.3	0.3	0.6	1.2	2.4	2,400
CTW5-L-100-T20-500	50:5	T20	0.3	0.3	0.6	1.2	2.4	4,715
CTW5-L-110-T20-750	75:5	T25	0.3	0.3	0.6	1.2	2.4	4,715
CTW5-L-110-T20-101	100:5	T25	0.3	0.3	0.6	1.2	2.4	8,625
CTW5-L-110-T20-151	150:5	T25	0.3	0.3	0.6	1.2	2.4	11,500
CTW5-L-110-T20-201	200:5	T30	0.3	0.3	0.6	1.2	2.4	11,500
CTW5-L-110-T20-251	250:5	T20	0.3	0.3	0.6	1.2	2.4	21,700
CTW5-L-110-T20-301	300:5	T25	0.3	0.3	0.6	1.2	2.4	21,700
CTW5-L-110-T20-401	400:5	T30	0.3	0.3	0.6	1.2	2.4	44,700
CTW5-L-110-T20-501	500:5	T35	0.3	0.3	0.3	0.6	1.2	44,700
CTW5-L-110-T20-601	600:5	T40	0.3	0.3	0.3	0.6	1.2	44,700

*For ordering with primary bars, change model number to CTWH5-L

A test card is provided with each unit.

Products are manufactured in a plant whose quality management system has been certified to be in compliance with ISO 9001:2015 by NQA

Wound Primary Indoor Current Transformer

**Model CTW5-L-110
CTWH5-L-110**

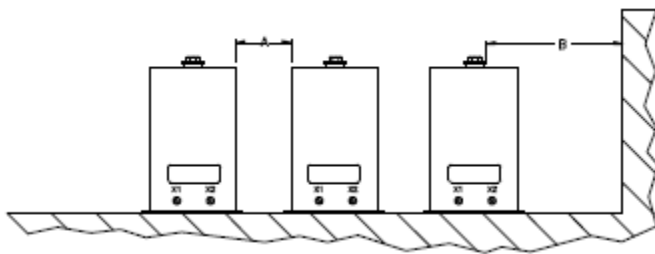
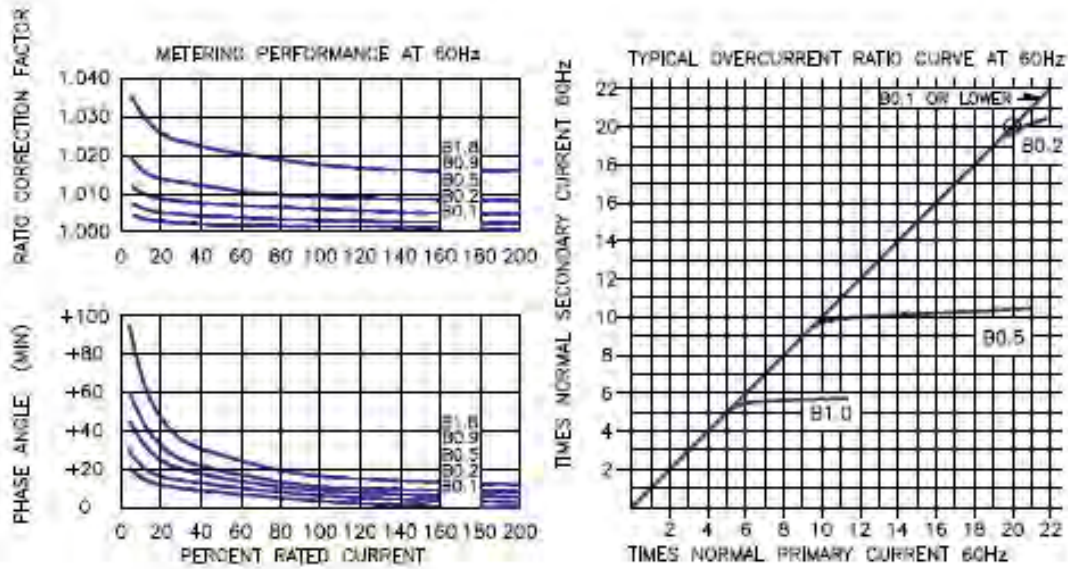

RECOMMENDED MINIMUM SPACINGS

A = Unit to Unit = 2.00" minimum.

B = HV to Ground in Air = 6.50" minimum.

Recommended spacing are for guidance only. User needs to set appropriate values to assure performance for high potential test, impulse test, high humidity, partial discharge, high altitude, and other considerations like configuration.

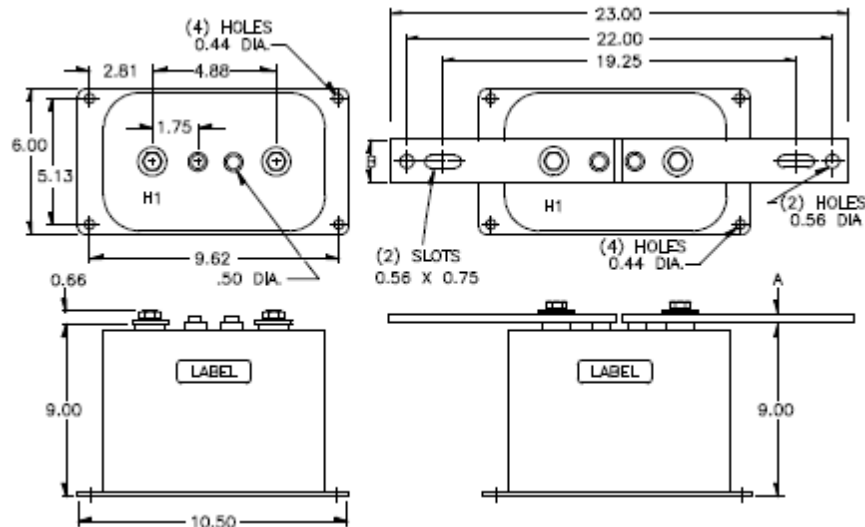

Wound Primary Indoor Current Transformer

Model CTWH3-60-T100

rev 071818

APPLICATION:

Relaying and metering

FREQUENCY:

50-400 Hz.

MAXIMUM SYSTEM VOLTAGE:

5.6Kv, BIL 60kV

APPROXIMATE WEIGHT:

41 lbs.

CONTINUOUS THERMAL RATING FACTOR:

1.5 at 30°C., 1.33 at 55°C.
250:5, 1000:5 AND 1,200:5-
1.10 at 30°C., 0.85 at 55°C.



CERTIFICATIONS:



Primary terminals are copper bars. See chart next pages for sizes.

Secondary terminals are brass screws No. 10-32 with one flatwasher, lockwasher.

Vacuum cast polyurethane resin. Other ratios, secondary currents and dual ratios are available. Refer to factory.

MODEL CTWH3-60-T100

Approximate weight: 41 lbs.

Catalog Number	Current Ratio	Relay Class	ANSI Metering Class at 60 Hz					**Thermal current Rating 1 Second RMS Amps
			BO.1	BO.2	BO.5	BO.9	B1.8	
CTWH3-60-T100-050	5:5	T100	0.3	0.3	0.3	0.3	0.3	470
CTWH3-60-T100-100	10:5	T100	0.3	0.3	0.3	0.3	0.3	900
CTWH3-60-T100-150	15:5	T100	0.3	0.3	0.3	0.3	0.3	1,600
CTWH3-60-T100-200	20:5	T100	0.3	0.3	0.3	0.3	0.3	1,900
CTWH3-60-T100-250	25:5	T100	0.3	0.3	0.3	0.3	0.3	2,600
CTWH3-60-T100-300	30:5	T100	0.3	0.3	0.3	0.3	0.3	2,900
CTWH3-60-T100-400	40:5	T100	0.3	0.3	0.3	0.3	0.3	3,800
CTWH3-60-T600-500	50:5	T100	0.3	0.3	0.3	0.3	0.3	4,700
CTWH3-60-T100-750	75:5	T100	0.3	0.3	0.3	0.3	0.3	5,900
CTWH3-60-T100-101	100:5	T100	0.3	0.3	0.3	0.3	0.3	8,600
CTWH3-60-T100-151	150:5	T100	0.3	0.3	0.3	0.3	0.3	12,900
CTWH3-60-T100-201	200:5	T100	0.3	0.3	0.3	0.3	0.3	17,200
CTWH3-60-T100-251	250:5	T100	0.3	0.3	0.3	0.3	0.3	17,200
CTWH3-60-T100-301	300:5	T100	0.3	0.3	0.3	0.3	0.3	34,500
CTWH3-60-T100-401	400:5	T100	0.3	0.3	0.3	0.3	0.3	34,500
CTWH3-60-T100-601	600:5	T100	0.3	0.3	0.3	0.3	0.3	66,200
CTWH3-60-T100-801	800:5	T100	0.3	0.3	0.3	0.3	0.3	66,200
CTWH3-60-T100-102	1,000:5	T100	0.3	0.3	0.3	0.3	0.3	66,200
CTWH3-600-T100-122	1,200:5	T100	0.3	0.3	0.3	0.3	0.3	66,200

**With a burden of B0.1 or greater connected to the secondary.

Products are manufactured in a plant whose quality management system has been certified to be in compliance with ISO 9001:2015 by NQA

Wound Primary Indoor Current Transformer

Model CTWH3-60-T100

Bar Sizes

Primary Current	Dimensions	
	A	B
5 to 250 A	0.25	1.50
300 to 1,200 A	0.38	2.00

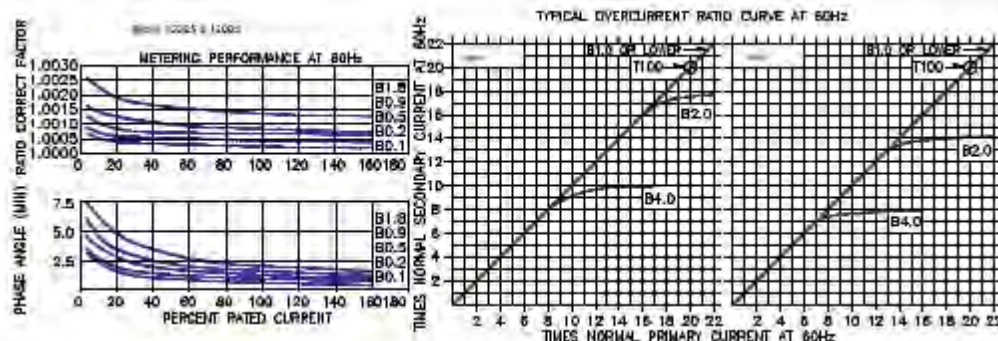
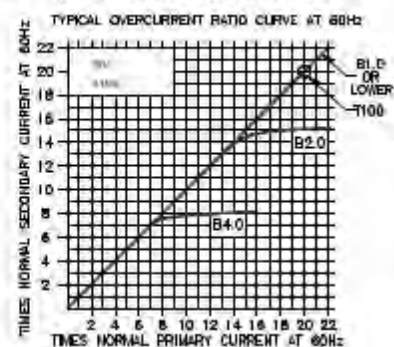
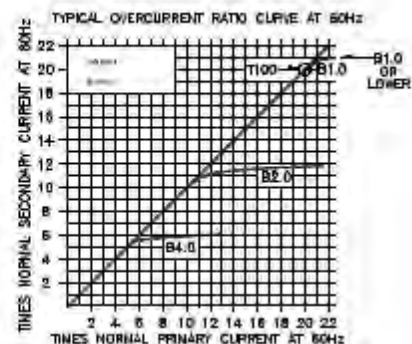
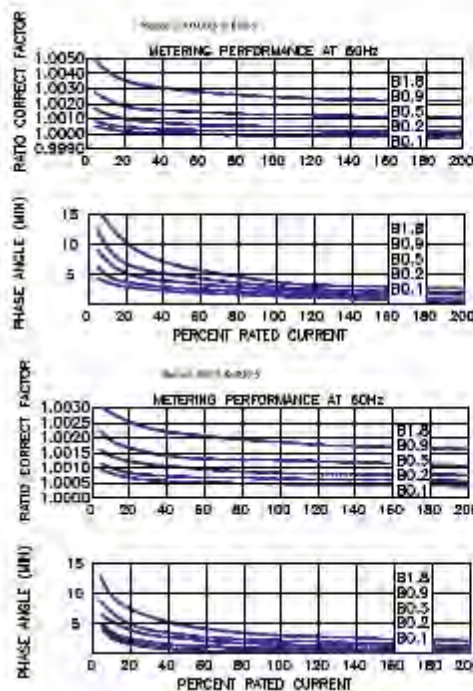

RECOMMENDED MINIMUM SPACINGS

A = Unit to Unit = 0.75" minimum.

B = HV to Ground in Air = 3.00" minimum.

Recommended spacing are for guidance only. User needs to set appropriate values to assure performance for high potential test, impulse test, high humidity, partial discharge, high altitude, and other considerations like configuration.

